

7 to 15 Ton ZR*KC and ZP*KC Copeland Scroll™ Compressors





TABLE OF CONTENTS

<u>Section</u>	<u>Page</u>	<u>Section</u>	<u>Page</u>
Safety			
Safety Instructions	2	Assembly Line Procedures	
Safety Icon Explanation	2	Compressor Handling	12
Instructions Pertaining to Risk of Electrical		Mounting	12
Shock, Fire, or Injury to Persons	3	Suction & Discharge Fittings.....	12
Safety Statements.....	3	Assembly Line Brazing Procedure.....	12
Introduction			
Nomenclature.....	4	Unbrazing System Components	12
Application Considerations			
Operating Envelope	4	Pressure Testing	12
Internal Pressure Relief (IPR) Valve	4	Assembly Line System Charging Procedures.....	13
Advanced Scroll Temperature Protection.....	4	Electrical Connections	13
Discharge Line Thermostat.....	5	Hipot Testing	13
High Pressure Control.....	5	Tandem Assembly.....	13
Low Pressure Control	5	Service Procedures	
Shut Down Device	5	Field Replacement.....	14
Discharge Check Valve	5	Mounting	14
Discharge Mufflers	5	Removing Oil	14
Compressor Cycling.....	5	Electrical	14
Piping Length & High Refrigerant Charge.....	6	Module	14
Suction & Discharge Line Noise & Vibration.....	6	Compressor Replacement after a Motor Burn	14
Suction & Discharge Fittings.....	6	Manifolded Compressor Replacement.....	15
System Tubing Stress	6	Start-Up of a New or Replacement Compressor	15
Accumulators	7	Field Troubleshooting the Kriwan Module.....	15
Crankcase Heat	7	Field Troubleshooting the CoreSense	
Pump Down Cycle	7	Communications Module	16
Reversing Valves	7	Scroll Functional Check	16
System Screens & Strainers	8	Refrigerant Retrofits.....	17
Contaminant Control.....	8	Figures & Tables	
Oil Type & Removal	8	How a Scroll Works.....	18
Three Phase Electrical Phasing.....	9	Scroll Operating Envelopes	19
Power Factor Correction	9	Compressor Terminal Box Wiring	20
Deep Vacuum Operation.....	9	ASTP Label.....	21
Manifolded Compressors	9	Crankcase Heater Location	21
Manifolded Applications	10	Scroll Suction Tube Brazing.....	22
Motor Protection.....	10	Field Application Test	23
Application Tests			
Application Test Summary	10	Design Configurations.....	23
Continuous Floodback Test.....	11	Compressor Accessories & Service Parts	24
Field Application Test	11	Refrigerant Charge Limits.....	25
		Torque Values	25
		Protector Specifications	26
		CoreSense LED Flash Code Information.....	26-27
		Tandem Oil Balancing	28
		Tilted Tandem.....	28
		APPENDIX	
		Kriwan to CoreSense Retrofit Instructions.....	29





Safety Instructions

Copeland Scroll™ compressors are manufactured according to the latest U.S. and European Safety Standards. Particular emphasis has been placed on the user's safety. Safety icons are explained below and safety instructions applicable to the products in this bulletin are grouped on Page 3. These instructions should be retained throughout the lifetime of the compressor. **You are strongly advised to follow these safety instructions.**

Safety Icon Explanation

	DANGER indicates a hazardous situation which, if not avoided, will result in death or serious injury.
	WARNING indicates a hazardous situation which, if not avoided, could result in death or serious injury.
	CAUTION, used with the safety alert symbol, indicates a hazardous situation which, if not avoided, could result in minor or moderate injury.
	NOTICE is used to address practices not related to personal injury.
	CAUTION, without the safety alert symbol, is used to address practices not related to personal injury.

Instructions Pertaining to Risk of Electrical Shock, Fire, or Injury to Persons

 <p>WARNING</p>	<p>ELECTRICAL SHOCK HAZARD</p> <ul style="list-style-type: none"> • Disconnect and lock out power before servicing. • Discharge all capacitors before servicing. • Use compressor with grounded system only. • Molded electrical plug must be used with all -1XX and -8XX bills of material. • Refer to original equipment wiring diagrams. • Electrical connections must be made by qualified electrical personnel. • Failure to follow these warnings could result in serious personal injury.
 <p>WARNING</p>	<p>PRESSURIZED SYSTEM HAZARD</p> <ul style="list-style-type: none"> • System contains refrigerant and oil under pressure. • Remove refrigerant from both the high and low compressor side before removing compressor. • Use appropriate back up wrenches on rotalock fittings when servicing. • Never install a system and leave it unattended when it has no charge, a holding charge, or with the service valves closed without electrically locking out the system. • Use only approved refrigerants and refrigeration oils. • Personal safety equipment must be used. • Failure to follow these warnings could result in serious personal injury.
 <p>WARNING</p>	<p>BURN HAZARD</p> <ul style="list-style-type: none"> • Do not touch the compressor until it has cooled down. • Ensure that materials and wiring do not touch high temperature areas of the compressor. • Use caution when brazing system components. • Personal safety equipment must be used. • Failure to follow these warnings could result in serious personal injury or property damage.
 <p>CAUTION</p>	<p>COMPRESSOR HANDLING</p> <ul style="list-style-type: none"> • Use the appropriate lifting devices to move compressors. • Personal safety equipment must be used. • Failure to follow these warnings could result in personal injury or property damage.

Safety Statements

- Refrigerant compressors must be employed only for their intended use.
- Only qualified and authorized HVAC or refrigeration personnel are permitted to install, commission and maintain this equipment.
- Electrical connections must be made by qualified electrical personnel.
- All valid standards and codes for installing, servicing, and maintaining electrical and refrigeration equipment must be observed.

Introduction

The 7 to 15 ton ZR*KC and ZP*KC Copeland Scroll™ compressors are designed for a wide variety of light commercial air-conditioning, heat pump, and chiller applications. This bulletin describes the operating characteristics, design features, and application requirements for these compressors.

For additional information, please refer to the online product information accessible from the Emerson Climate Technologies website at www.emersonclimate.com. Operating principles of the Copeland Scroll compressor are described in **Figure 1** of this bulletin.

The ZR*KC and ZP*KC scrolls outlined in this bulletin range in size from 84,000 to 190,000 Btu/hr (24.6 to 55.7 kW) and 90,000 to 182,000 Btu/hr (26.4 to 53.3 kW) respectively. These models include all of the standard 50 and 60 Hertz three phase voltages. Compressors in this size range include a number of features outlined in **Table 1** below.

Nomenclature

The model numbers of the Copeland Scroll compressors include the approximate nominal 60 Hz capacity at standard operating conditions. An example would be the ZP90KCE-TFD, which has 90,500 But/hr (26.5kW) cooling capacity at the AHRI high temperature air conditioning rating point when operated at 60 Hz. Note that the same compressor will have approximately 5/6 of this capacity or 74,500 Btu/hr (21.8kW) when operated at 50 Hz.

Application Considerations

The following application guidelines should be considered in the design of a system using ZR*KC and ZP*KC scroll compressors. Some of this information is recommended, whereas other guidelines must be followed. The Application Engineering department will always welcome suggestions that will help improve these types of documents.

Operating Envelope

NOTICE

It is essential that the glide of R-407C is carefully considered when adjusting pressure and superheat controls.

Figure 2 illustrates the operating envelopes for the ZR*KC and ZP*KC compressors with R-22/R-407C/R-134a and R-410A respectively. The operating envelopes represent operating conditions with 20F° (11K) superheat in the return gas. The steady-state operating condition of the compressor must remain inside the prescribed operating envelope. Excursions outside of the envelope should be brief and infrequent. Use of refrigerants other than R-22, R-407C, or R-134a with ZR*KCE and R-410A with ZP*KCE voids the compressor UL recognition.

Internal Pressure Relief (IPR) Valve

WARNING

A high pressure control must be used in all applications.

These models of Copeland Scroll compressors do not have internal pressure relief valves. **To ensure safe operation, a high pressure control must be used in all applications.**

Advanced Scroll Temperature Protection (ASTP)

A Therm-O-Disc™ temperature-sensitive snap disc provides compressor protection from discharge gas overheating. Events such as loss of charge, evaporator blower failure, or low side charging with inadequate pressure will cause the discharge gas to quickly rise above a critical temperature. Once this critical temperature is reached, the ASTP feature will cause the scrolls to separate and stop pumping but allow the motor to continue to run. After the compressor runs for some time without pumping gas, the motor overload

Table 1 – Copeland Scroll™ Family Features

Model	Application		IPR Valve	Discharge Temperature Protection (ASTP)	Quiet Shutdown	Discharge Check Valve	Motor Protection	Electrical Connections ¹
	A/C	Heat Pump						
ZR84-144KCE-TF*	Yes	Yes	No	Yes	Yes	Yes	Internal	MP, TB
ZR160-190KCE-TE/W*	Yes	Yes	No	Yes	Yes	Yes	Module	TB
ZP90-137KCE-TF*	Yes	Yes	No	Yes	Yes	Yes	Internal	MP, TB
ZP154-182KCE-TE/W*	Yes	Yes	No	Yes	Yes	Yes	Module	TB

* Last Character In Voltage Code (5 = 200/230-3-60, 200/220-3-50; D = 460-3-60, 380/420-3-50; E = 575-3-60; 7 = 380-3-60)
¹ MP = Molded Plug, TB = Terminal Block & Ring Terminals

protector will open. Depending on the heat buildup in the compressor, it may take up to two hours for the ASTP to reset. The addition of the Advanced Scroll Temperature Protection makes it possible to eliminate the discharge line thermostat previously required in heat pump applications. A graphic explanation and a short video clip are available on our website at www.emersonclimate.com/ASTP. Compressors in this size range that have ASTP are identified with the ASTP label shown in **Figure 4**.

Discharge Line Thermostat

A discharge temperature thermostat is not an application requirement because of the built-in ASTP feature that protects the compressor against abnormally high discharge temperatures. If the system designer wants to prevent ASTP trips and limit the maximum compressor discharge temperature to a lower temperature, a discharge temperature switch should be used. **Table 4** lists available discharge line thermostats that strap on to the discharge line of the compressor for the highest level of compressor reliability.

High Pressure Control

A high pressure cut-out control must be used in all applications. The maximum cut out setting is 425 psig (30 bar) for R-22, R-407C, and R-134a and 650 psig (45 bar) for R-410A. The high pressure control should have a manual reset feature for the highest level of system protection.

Low Pressure Control

A low pressure control is highly recommended for loss of charge protection and other system fault conditions that may result in very low evaporating temperatures. Even though these compressors have internal discharge temperature protection, loss of system charge will result in overheating and recycling of the motor overload protector. Prolonged operation in this manner could result in oil pump out and eventual bearing failure.

The low pressure cut-out setting will depend on the application type and minimum expected evaporating temperature. The low pressure cut-out should be selected to prevent compressor overheating and other system failure modes such as coil icing in air conditioning systems and frozen heat exchangers in chiller systems. The minimum, recommended low pressure cut-out switch settings are:

Air conditioning and chiller:

- 55 psig/3.8 bar (R-410A)
- 25 psig/1.7 bar (R-22 & R-407C)
- 10 psig/0.7 bar (R-134a)

Heat pumps:

- 20 psig/1.4 bar (R-410A)
- 10 psig/0.7 bar (R-22, R-407C, & R-134a)

Shut Down Device

All scrolls in this size range have floating valve technology to mitigate shut down noise. Since Copeland Scroll™ compressors are also excellent gas expanders, they may spin backwards for a brief period after shutdown as the internal pressures equalize.

Discharge Check Valve

A low mass, disk-type check valve in the discharge fitting of the compressor prevents the high side, high pressure discharge gas from flowing rapidly back through the compressor after shutdown. This check valve was not designed to be used with recycling pump down because it is not entirely leak-proof.

Discharge Mufflers

Flow through Copeland Scroll compressors is semi-continuous with relatively low pulsation. External mufflers, where they are normally applied to piston compressors today, may not be required for Copeland Scroll compressors. Because of variability between systems, however, individual system tests should be performed to verify acceptability of sound performance. When no testing is performed, mufflers are recommended in heat pumps. The muffler should be located a minimum of six inches (15 cm) to a maximum of 18 inches (46 cm) from the compressor for the most effective operation. The further the muffler is placed from the compressor within these ranges the more effective it may be. If adequate attenuation is not achieved, use a muffler with a larger cross-sectional area to inlet-area ratio. The ratio should be a minimum of 20:1 with a 30:1 ratio recommended. The muffler should be from four to six inches (10 -15 cm) long.

Compressor Cycling

There is no set answer to how often scroll compressors can be started and stopped in an hour, since it is highly dependent on system configuration. There is no minimum off time because Copeland Scroll compressors start unloaded, even if the system has unbalanced pressures. The most critical consideration is the minimum run time required to return oil to the compressor after startup. To establish the minimum run time, obtain a sample compressor equipped with a sight tube (available from Emerson) and install it in a system with the longest connecting lines that are approved for the system. The minimum on time becomes the time required for oil lost during compressor startup to return to the compressor sump

and restore a minimal oil level that will assure oil pick up through the crankshaft. **The minimum oil level required in the compressor is 1.5" (40 mm) below the center of the compressor sight-glass.** Cycling the compressor for a shorter period than this, for instance to maintain very tight temperature control, will result in progressive loss of oil and damage to the compressor. See **AE17-1262** for more information on preventing compressor short cycling.

Long Pipe Lengths / High Refrigerant Charge

Some system configurations may contain higher-than-normal refrigerant charges either because of large internal coil volumes or long line sets. If such a system also contains an accumulator then the permanent loss of oil from the compressor may become critical. If the system contains more than 20 pounds (9 kg) of refrigerant, it is our recommendation to add one fluid ounce of oil for every 5 pounds (15 ml/kg) of refrigerant over this amount. If the system contains an accumulator the manufacturer of the accumulator should be consulted for a pre-charge recommendation.

Other system components such as shell and tube evaporators can trap significant quantities of oil and should be considered in overall oil requirements. Reheat coils and circuits that are inactive during part of the normal cycle can trap significant quantities of oil if system piping allows the oil to fall out of the refrigerant flow into the inactive circuit. The oil level must be carefully monitored during system development, and corrective action should be taken if the compressor oil level falls more than 1.5" (40 mm) below the center of the sight-glass. **The compressor oil level should be checked with the compressor "off" to avoid the sump turbulence when the compressor is running.**

These compressors are available to the OEM with a production sight-glass that can be used to determine the oil level in the compressor in the end-use application. These compressors are also available to the OEM with an oil Schrader fitting on the side of the compressor to add additional oil if needed because of long lengths of piping or high refrigerant charge. **No attempt should be made to increase the oil level in the sight-glass above the 3/4 full level. A high oil level is not sustainable in the compressor and the extra oil will be pumped out into the system causing a reduction in system efficiency and a higher-than-normal oil circulation rate.**

Suction & Discharge Line Noise and Vibration

Copeland Scroll™ compressors inherently have low sound and vibration characteristics. However, the sound

and vibration characteristics differ in some respects from those of reciprocating compressors. In rare instances, these could result in unexpected sound complaints.

One difference is that the vibration characteristics of the scroll compressor, although low, include two very close frequencies, one of which is normally isolated from the shell by the suspension of an internally suspended compressor. These frequencies, which are present in all compressors, may result in a low level "beat" frequency that may be detected as noise coming along the suction line into the building under some conditions. Elimination of the "beat" can be achieved by attenuating either of the contributing frequencies. The most important frequencies to avoid are 50 and 60 Hz power supply line. This is easily done by using one of the common combinations of design configuration described in **Table 3**. The scroll compressor makes both a rocking and torsional motion, and enough flexibility must be provided in the line to prevent vibration transmission into any lines attached to the unit. In a split system the most important goal is to ensure minimal vibration is all directions at the service valve to avoid transmitting vibrations to the structure to which the lines are fastened.

A second difference of the Copeland Scroll compressor is that under some conditions the normal rotational starting motion of the compressor can transmit an "impact" noise along the suction line. This phenomenon, like the one described previously, also results from the lack of internal suspension, and can be easily avoided by using standard suction line isolation techniques as described in **Table 3**.

The sound phenomena described above are not usually associated with heat pump systems because of the isolation and attenuation provided by the reversing valve and tubing bends.

Suction and Discharge Fittings

Copeland Scroll compressors have copper plated steel suction and discharge fittings. These fittings are far more rugged and less prone to leaks than copper fittings used on other compressors. Due to the different thermal properties of steel and copper, brazing procedures may have to be changed from those commonly used. See **Figure 6** for assembly line and field brazing recommendations.

System Tubing Stress

System tubing should be designed to keep tubing stresses below 9.5 ksi (62 MPa), the endurance limit of copper tubing. Start, stop and running (resonance) cases should be evaluated.

Accumulators

The use of accumulators is very dependent on the application. The Copeland Scroll™ compressor's inherent ability to handle liquid refrigerant during occasional operating flood back situations makes the use of an accumulator unnecessary in standard designs such as condensing units. Applications such as heat pumps with orifice refrigerant control that allow large volumes of liquid refrigerant to flood back to the compressor during normal steady operation can dilute the oil to such an extent that bearings are inadequately lubricated, and wear will occur. In such a case an accumulator must be used to reduce flood back to a safe level that the compressor can handle. Heat pumps designed with a TXV to control refrigerant during heating may not require an accumulator if testing assures the system designer that there will be no flood back throughout the operating range. To test for flood back conditions and to determine if the accumulator or TXV design is adequate, please see the section entitled **Application Tests**.

A large-area protective screen no finer than 30x30 mesh (0.6mm openings) is required to protect this small orifice from plugging. Tests have shown that a small screen with a fine mesh can easily become plugged causing oil starvation to the compressor bearings. The size of the accumulator depends upon the operating range of the system and the amount of sub cooling and subsequent head pressure allowed by the refrigerant control. System modeling indicates that heat pumps that operate down to and below 0°F (-18°C) will require an accumulator that can hold around 70% to 75% of the system charge. Behavior of the accumulator and its ability to prevent liquid slugging and subsequent oil pump-out at the beginning and end of the defrost cycle should be assessed during system development. This will require special accumulators and compressors with sight tubes and/or sight glasses for monitoring refrigerant and oil levels.

Crankcase Heat

A 90 watt crankcase heater is required when the system charge exceeds the values listed in **Table 5**. This requirement is independent of system type and configuration. **Table 5** lists Emerson crankcase heaters by part number and voltage. See **Figure 6** for the proper heater location on the compressor shell. **The crankcase heater must remain energized during compressor off cycles.**

The initial start-up in the field is a very critical period for any compressor because all load-bearing surfaces are new and require a short break-in period to carry high loads under adverse conditions. **The crankcase heater must be turned on a minimum of 12 hours prior to**

starting the compressor. This will prevent oil dilution and bearing stress on initial start up.

To properly install the crankcase heater, the heater should be installed in the location illustrated in **Figure 5**. Tighten the clamp screw carefully, ensuring that the heater is uniformly tensioned along its entire length and that the circumference of the heater element is in complete contact with the compressor shell. It's important that the clamp screw is torqued to the range of 20-25 in-lb (2.3-8 N-m) to ensure adequate contact and to prevent heater burnout. Never apply power to the heater in free air or before the heater is installed on the compressor to prevent overheating and burnout. **WARNING! Crankcase heaters must be properly grounded.**

Pump Down Cycle

A pump down cycle for control of refrigerant migration is not recommended for scroll compressors of this size. **If a pump down cycle is used, a separate discharge line check valve must be added.** The scroll compressor's discharge check valve is designed to stop extended reverse rotation and to prevent high-pressure gas from leaking rapidly into the low side after shut off. The check valve will in some cases leak more than reciprocating compressor discharge reeds, normally used with pump down, causing the scroll compressor to recycle more frequently. Repeated short-cycling of this nature can result in a low oil situation and consequent damage to the compressor. The low-pressure control differential has to be reviewed since a relatively large volume of gas will re-expand from the high side of the compressor into the low side after shut down. **Pressure control setting: Never set the low pressure control to shut off outside of the operating envelope. The low pressure control should be set to open no lower than 5 to 10F° (3-6K) equivalent suction pressure below the lowest expected evaporating temperature.**

Reversing Valves

Since Copeland Scroll compressors have very high volumetric efficiency, their displacements are lower than those of comparable capacity reciprocating compressors. **CAUTION Reversing valve sizing must be within the guidelines of the valve manufacturer. Required pressure drop to ensure valve shifting must be measured throughout the operating range of the unit and compared to the valve manufacturer's data. Low ambient heating conditions with low flow rates and low pressure drop across the valve can result in a valve not shifting. This can result in a condition where the compressor appears to be not pumping (i.e. balanced pressures). It can also**

result in elevated compressor sound levels. During a defrost cycle, when the reversing valve abruptly changes the refrigerant flow direction, the suction and discharge pressures will go outside of the normal operating envelope. The sound that the compressor makes during this transition period is normal, and the duration of the sound will depend on the coil volume, outdoor ambient, and system charge level. The preferred method of mitigating defrost sound is to shut down the compressor for 20 to 30 seconds when the reversing valve changes position going into and coming out of the defrost cycle. This technique allows the system pressures to reach equilibrium without the compressor running. The additional start-stop cycles do not exceed the compressor design limits, but suction and discharge tubing design should be evaluated.

The reversing valve solenoid should be wired so that the valve does not reverse when the system is shut off by the operating thermostat in the heating or cooling mode. If the valve is allowed to reverse at system shutoff, suction and discharge pressures are reversed to the compressor. This results in pressures equalizing through the compressor which can cause the compressor to slowly rotate backwards until the pressures equalize. This condition does not affect compressor durability but can cause unexpected sound after the compressor is turned off.

System Screens & Strainers

Screens finer than 30x30 mesh (0.6mm openings) should not be used anywhere in the system. Field experience has shown that finer mesh screens used to protect thermal expansion valves, capillary tubes, or accumulators can become temporarily or permanently plugged with normal system debris and block the flow of either oil or refrigerant to the compressor. Such blockage can result in compressor failure.

Contaminant Control

Copeland Scroll™ compressors leave the factory with a miniscule amount of contaminants. Manufacturing processes have been designed to minimize the introduction of solid or liquid contaminants. Dehydration and purge processes ensure minimal moisture levels in the compressor, and continuous auditing of lubricant moisture levels ensures that moisture isn't inadvertently introduced into the compressor.

It is generally accepted that system moisture levels should be maintained below 50 ppm. **A filter-drier is required on all POE lubricant systems to prevent solid particulate contamination, oil dielectric strength degradation, ice formation, oil hydrolysis, and metal corrosion.** It is the system designer's

responsibility to make sure that the filter-drier is adequately sized to accommodate the contaminants from system manufacturing processes which leave solid or liquid contaminants in the evaporator coil, condenser coil, and interconnecting tubing plus any contaminants introduced during the field installation process. Molecular sieve and activated alumina are two filter-drier materials designed to remove moisture and mitigate acid formation. A 100% molecular sieve filter can be used for maximum moisture capacity. A more conservative mix, such as 75% molecular sieve and 25% activated alumina, should be used for service applications.

Oil Type & Removal

Mineral oil is used in the ZR*KC compressors for R-22 applications. Polyolester (POE) oil is used in the ZR*KCE and ZP*KCE compressors for R-22/R-407C/R-134a and R-410A applications respectively. See the compressor nameplate for the original oil charge. A complete recharge should be approximately four fluid ounces (118 ml) less than the nameplate value.

If additional oil is needed in the field for POE applications, Copeland™ Ultra 32-3MAF, Lubrizol Emkarate RL32-3MAF, Parker Emkarate RL32-3MAF/ (Virginia) LE32-3MAF, or Nu Calgon 4314-66 (Emkarate RL32-3MAF) should be used. Copeland™ Ultra 22 CC, Hatcol EAL 22CC, and Mobil EAL Arctic 22 CC are acceptable alternatives.

If additional oil is needed in the field for mineral oil applications, Sonneborn Suniso 3GS or Chevron Texaco Capella WF32 should be used.

When a compressor is exchanged in the field it is possible that a major portion of the oil from the replaced compressor may still be in the system. While this may not affect the reliability of the replacement compressor, the extra oil will add to rotor drag and increase power usage. To remove this excess oil an access valve port has been added to the lower shell of the service compressor. After running the replacement compressor for a minimum of 10 minutes, shut down the compressor and drain excess oil from the Schrader valve until the oil level is at one-half of the sight-glass level. This should be repeated twice to make sure the proper oil level has been achieved.

CAUTION POE must be handled carefully and the proper protective equipment (gloves, eye protection, etc.) must be used when handling POE lubricant. POE must not come into contact with any surface or material that might be harmed by POE, including without limitation, certain polymers (e.g. PVC/CPVC and polycarbonate).

Three Phase Scroll Compressor Electrical Phasing

NOTICE

Compressors that employ CoreSense technology have phase protection and will be locked out after one reverse phase event.

Copeland Scroll compressors, like several other types of compressors, will only compress in one rotational direction. Three phase compressors will rotate in either direction depending upon phasing of the power. Since there is a 50% chance of connecting power in such a way as to cause rotation in the reverse direction, **it is important to include notices and instructions in appropriate locations on the equipment to ensure that proper rotation direction is achieved when the system is installed and operated.** Verification of proper rotation direction is made by observing that suction pressure drops and discharge pressure rises when the compressor is energized. Reverse rotation will result in no pressure differential as compared to normal values. A compressor running in reverse will sometimes make an abnormal sound.

There is no negative impact on durability caused by operating three phase Copeland Scroll™ compressors in the reversed direction for a short period of time (under one hour). After several minutes of reverse operation, the compressor's internal overload protector will trip shutting off the compressor. If allowed to repeatedly restart and run in reverse without correcting the situation, the compressor bearings will be permanently damaged because of oil loss to the system. All three-phase scroll compressors are wired identically internally. As a result, once the correct phasing is determined for a specific system or installation, connecting properly phased power leads to the identified compressor electrical (Fusite™) terminals will maintain the proper rotational direction (see **Figure 3**). It should be noted that all three-phase scrolls will continue to run in reverse until the internal overload protector opens or the phasing is corrected.

Power Factor Correction

If power factor correction is necessary in the end-use application, please see **AE9-1249** for more information on this topic.

Deep Vacuum Operation

Copeland Scroll compressors incorporate internal low vacuum protection and will stop pumping (unload) when the pressure ratio exceeds approximately 10:1. There is an audible increase in sound when the scrolls start unloading.

CAUTION! Copeland Scroll compressors (as with any refrigerant compressor) should never be used to evacuate a refrigeration or air conditioning system. The scroll compressor can be used to pump down refrigerant in a unit as long as the pressures remain within the operating envelope shown in **Figure 2**. Prolonged operation at low suction pressures will result in overheating of the scrolls and permanent damage to the scroll tips, drive bearing and internal seal. See **AE24-1105** for proper system evacuation procedures.

Manifolded Compressors

Tandem compressor assemblies are available for purchase from Emerson. In lieu of purchasing the assembled tandem, the OEM can choose to purchase the manifold-ready compressor and perform the assembly in their factory. All of the ZP*KC and ZR*KC compressors are available for manifolding with another compressor in this compressor family. Manifold-ready compressors are designated with a -4XX bill of material number at the end of the model number (e.g. ZP120KCE-TFD-422). Drawings of tandem and trio compressor assemblies are available from Emerson Climate Technologies by contacting your Application Engineer. **NOTICE Customers who choose to design and build their own manifolds for tandem and trio compressor assemblies are ultimately responsible for the reliability of those manifold sets.**

The suction manifold is close to a symmetrical layout with the design intent of equal pressure drop to each compressor. A straight length of pipe is connected to the suction manifold "T" connection to serve as a flow straightener to make the flow as uniform as possible. The discharge manifold is the less critical of the two manifolds in terms of pressure drop. Low pipe stress and reliability are its critical design characteristics.

Two different oil balancing techniques are used with tandems in this family of compressors – two-phase tandem line (TPTL) and oil equalization line (OEL). For trio assemblies, only the TPTL design has been qualified. The TPTL design is a larger diameter pipe connecting the oil sumps of the individual compressors allowing both gas and oil to flow between the compressors at the same time. To install the TPTL, the individual sight-glasses on each compressor must be removed to allow the TPTL to screw on to the sight-glass fitting on the compressors. A sight-glass is installed on the TPTL to view the presence of oil (see **Figure 9**).

The OEL design is a 3/8" (10mm) copper tube connecting the oil sumps of the individual compressors allowing the flow of oil between the compressor sumps. To install the OEL, the oil drain Schrader fitting on each

compressor must be removed to expose the stub tube fitting for a brazed connection (see **Tandem Assembly** section). The OEL has an oil drain Schrader fitting on the 3/8" OEL tube for adding/removing oil (see **Figure 9**). The OEL design allows the individual oil levels in each compressor to be viewed, which isn't possible with the TPTL.

Manifolded Applications

NOTICE

Manifolded compressor designs employ a passive oil management system. All system designs must be tested by the OEM to ensure that the passive design will provide adequate oil balancing between the compressors in the manifolded set under all operating conditions. If inadequate oil balancing can't be demonstrated, an active oil management system should be considered.

Manifolded compressors follow the same application guidelines as single compressors outlined in this bulletin. The refrigerant charge limit for tandem compressors is shown in **Table 5**. A tandem circuit with a charge over this limit must have crankcase heaters applied to both compressors.

Oil levels in the individual sight-glasses will vary, depending on whether one or more compressors in the manifolded set are operating and if the manifolded set is made up of equal or unequal compressor capacities. Because of the unequal oil levels that can exist, oil levels should be viewed with the compressors off to allow the oil level to stabilize between the compressor sumps. With the compressors off, oil should be visible in the individual compressor sight-glasses when the OEL is used, or in the sight-glass on the TPTL. If oil is not visible, additional oil should be added to the system.

Suction and discharge tandem manifolds are not designed to support system piping. Support means must be provided by the system designer to support suction and discharge lines so that stress is not placed on the manifolds.

The compressors in a manifolded set can be started/stopped in any desired sequence. To help reduce inrush current, starting the compressors individually is recommended.

Please consult with Application Engineering during the development of systems with trio compressor assemblies. Trio compressor assemblies are sensitive to system operating conditions and configurations which will affect oil balancing. Trio compressor assemblies must be qualified for each application.

Motor Overload Protection

Models with Electrical Code TF

Models with an "F" in the electrical code (i.e. ZP120KCE-TFD), have an internal line break motor overload located in the center of the Y of the motor windings. This overload disconnects all three legs of the motor from power in case of an over-current or over-temperature condition. The overload reacts to a combination of motor current and motor winding temperature. The internal overload protects against single phasing. Time must be allowed for the motor to cool down before the overload will reset. If current monitoring to the compressor is available, the system controller can take advantage of the compressor internal overload operation. The controller can lock out the compressor if current draw is not coincident with contactor energizing, implying that the compressor has shut off on its internal overload. This will prevent unnecessary compressor cycling on a fault condition until corrective action can be taken.

Models with Electrical Code TW* or TE*

WARNING

The electronic motor protection module is a U.L. recognized safety device and must be used with all compressors that have TW* electrical codes and TE* electrical codes respectively.

Models with a "W" or "E" in the electrical code (i.e. ZP182KCE-TWD) have a motor overload system that consists of an external electronic control module connected to a chain of four thermistors embedded in the motor windings. The module will trip and remain off for a minimum of 30 minutes if the motor temperature exceeds a preset point.

Note: Turning off power to the module will reset it immediately.

The module has a 30 minute time delay to allow the scrolls to cool down after the motor temperature limit has been reached. **CAUTION Restarting the compressor sooner may cause a destructive temperature build up in the scrolls.** For this reason, module power must never be switched off with the control circuit voltage. Since the compressor is dependent upon the contactor to disconnect it from power in case of a fault, the contactor must be selected in accordance with **AE10-1244**. The contactor must meet both the Rated Load Amps (RLA) and Locked Rotor Amps (LRA) specified for the compressor.

APPLICATION TESTS

Application Test Summary

There are a minimal number of tests the system

designer will want to run to ensure the system operates as designed. These tests should be performed during system development and are dependent on the system type and amount of refrigerant charge. These application tests are to help identify gross errors in system design that may produce conditions that could lead to compressor failure. The Continuous Floodback Test and Field Application Test, both outlined below, are two tests to run to help verify the design. When to run these tests can be summarized as follows.

For manifolded compressor assemblies, oil balancing tests must be performed to demonstrate oil balancing between the compressors. Compressors with sight-tubes for viewing a wide range of oil levels is appropriate for this type of testing. The least amount of testing will evaluate the minimum and maximum flow conditions at which the compressors will be required to operate, with min and max suction superheat.

Continuous Floodback:

Required for all air-source heatpumps.

Field Application Test:

Required for any unit where both the design system charge is higher than the compressor refrigerant charge limit listed in **Table 5**; and a capillary tube, fixed orifice, or bleed-type TXV is used on either the indoor or the outdoor coil of the unit.

Continuous Floodback Test

It is expected that the design would not flood during standard air conditioning operation. Flooding during defrost cycles should be minimal and the flow control device must regain control of the refrigerant flow after the defrost cycle to ensure suction gas superheat. The use of a TXV in heating does not guarantee operation without flood back in the lower end of the unit/TXV operating range.

To test for excessive continuous liquid refrigerant flood back, it is necessary to operate the system in a test room at conditions where steady state flood back may occur (low ambient heating operation). Thermocouples should be attached with glue or solder to the center of the bottom shell and to the suction and discharge lines approximately 6 inches (15 cm) from the shell. These thermocouples should be insulated from the ambient air with Permagum™ or other thermal insulation to be able to record true shell and line temperatures. If the system is designed to be field charged, it should be overcharged by 15% in this test to simulate overcharging often found in field installations.

The system should be operated at an indoor temperature of 70°F (21°C) and outdoor temperature extremes of 10°F (-12°C) or lower in heating to produce

flood back conditions. The compressor suction and discharge pressures and temperatures as well as the sump temperature should be recorded. The system should be allowed to frost up for several hours (disabling the defrost control and spraying water on the outdoor coil may be necessary) to cause the saturated suction temperature to fall below 0°F (-18°C). The suction superheat must remain positive or design changes must be made to increase suction superheat and reduce flooding. Increasing indoor coil volume, increasing outdoor air flow, reducing refrigerant charge, decreasing capillary or orifice diameter, and adding a charge compensator can also be used to reduce excessive continuous liquid refrigerant flood back.

Field Application Test

To test for repeated, excessive liquid flood back during normal system off-cycles, perform the **Field Application Test** that is outlined in **Table 2**. Obtain a sample compressor with a sight-tube to measure the liquid level in the compressor when it is off.

Note: The sight-tube is not a good liquid level indicator when the compressor is running because the top of the sight-tube is at a lower pressure than the bottom causing a higher apparent oil level.

Set the system up in a configuration with the indoor unit elevated several feet above the outdoor unit with a minimum of 25 feet (8 meters) of connecting tubing with no traps between the indoor and outdoor units. If the system is designed to be field charged, the system should be overcharged by 15% in this test to simulate field overcharging. Operate the system in the cooling mode at the outdoor ambient, on/off cycle times, and number of cycles specified in **Table 2**. Record the height of the liquid in the compressor at the start of each on cycle, any compressor overload trips, or any compressor abnormal starting sounds during each test. Review the results with Application Engineering to determine if an accumulator or other means of off cycle migration control are required. **This test does not eliminate the requirement for a crankcase heater if the system charge level exceeds the values in Table 5.** The criteria for pass/fail is whether the liquid level reaches the bottom of the terminal box. Liquid levels higher than this can allow refrigerant/oil to be ingested by the scrolls and pumped out of the compressor after start-up.

The tests outlined above are for common applications of compressors in this family. Many other applications of the compressor exist, and tests to insure those designs can't possibly be covered in this bulletin. Please consult with Application Engineering on applications outside of those outlined above for the

appropriate application tests.

ASSEMBLY LINE PROCEDURES

Compressor Handling

WARNING

Use care and the appropriate material handling equipment when lifting and moving compressors. Personal safety equipment must be used.

Because oil might spill out of the suction connection located low on the shell, the suction connection plug must be left in place until the compressor is set into the unit. If possible, the compressor should be kept vertical during handling. The discharge connection plug should be removed first before pulling the suction connection plug to allow the dry air pressure inside the compressor to escape. Pulling the plugs in this sequence prevents oil mist from coating the suction tube making brazing difficult. **The copper coated steel suction tube should be cleaned before brazing (see Figure 6).** No object (e.g. a swaging tool) should be inserted deeper than two inches (51 mm) into the suction tube, or it might damage the suction screen and motor.

Mounting

The tested rubber mounting grommet and sleeve kit is listed in **Table 4**. This drawing can be found at www.emersonclimate.com under the Miscellaneous tab in the **Online Product Information (OPI)**. For applications such as tandems or mobile applications, the compressor should be hard mounted directly to the rails or base to relieve stress on the tubing. An additional bellyband brace must be used with mobile applications to keep compressor movement to a minimum and relieve stress on both the feet and the tubing. The steel spacer developed for such applications is the **027-0385-00**.

Many OEM customers buy the mounting parts directly from the supplier, but Emerson's grommet design and durometer recommendations should be followed for best vibration reduction through the mounting feet.

Suction and Discharge Fittings

These compressors are available with stub tube or Rotalock connections. The stub tube version has copper-plated steel suction and discharge fittings. These fittings are far more rugged than copper fittings used on other compressors. Due to the different thermal properties of steel and copper, brazing procedures may have to be changed from those commonly used. See **Figure 6** for assembly line and field brazing procedures and **Table 6** for Rotalock torque values.

Assembly Line Brazing Procedure

WARNING

Personal safety equipment must be used during brazing operation. Heat shields should be used to prevent overheating or burning nearby temperature sensitive parts. Fire extinguishing equipment should be accessible in the event of a fire.

Figure 6 discusses the proper procedures for brazing the suction and discharge lines to a scroll compressor. **NOTICE It is important to flow nitrogen through the system while brazing all joints during the system assembly process.** Nitrogen displaces the air and prevents the formation of copper oxides in the system. If allowed to form, the copper oxide flakes can later be swept through the system and block screens such as those protecting capillary tubes, thermal expansion valves, and accumulator oil return holes. The blockage – whether it is of oil or refrigerant – is capable of doing damage resulting in compressor failure.

Unbrazing System Components

WARNING

Before attempting to braze, it is important to recover all refrigerant from both the high and low side of the system.

If the refrigerant charge is removed from a scroll-equipped unit by evacuating the high side only, it is possible for the scrolls to seal, preventing pressure equalization through the compressor. This may leave the low side shell and suction line tubing pressurized. If a brazing torch is then applied to the low side while the low side shell and suction line contain pressure, the pressurized refrigerant and oil mixture could ignite when it escapes and contacts the brazing flame. **CAUTION! It is important to check both the high pressure and low pressure sides with manifold gauges before unbrazing.** Instructions should be provided in appropriate product literature and assembly (line repair) areas. If compressor removal is required, the compressor should be cut out of system rather than unbrazed. See **Figure 6** for the proper compressor removal procedure.

Pressure Testing

WARNING

Never pressurize the compressor to more than 400 psig (27.6 bar) for ZR*KCE and 475 psig (32.8 bar) for ZP*KCE compressors. Never pressurize the compressor from a nitrogen cylinder or other pressure source without an appropriately sized

pressure regulating and relief valve.

Higher pressure may result in permanent deformation of the compressor shell and possibly cause misalignment or bottom cover distortion.

Assembly Line System Charging Procedure

Systems should be charged with liquid on the high side to the extent possible. The majority of the charge should be pumped in the high side of the system to prevent low voltage starting difficulties, hipot failures, and bearing washout during the first-time start on the assembly line. If additional charge is needed, it should be added as **liquid** to the low side of the system with the compressor operating. Pre-charging on the high side and adding liquid on the low side of the system are both meant to protect the compressor from operating with abnormally low suction pressures during charging. **NOTICE Do not operate the compressor without enough system charge to maintain at least 55 psig (3.8 bar) suction pressure for R-410A and 20 psig (1.4 bar) for R-22 & R-407C. Do not operate the compressor with the low pressure cut-out disabled. Do not operate with a restricted suction or liquid line. Do not use the compressor to test the opening set point of a high pressure cutout.** Bearings are susceptible to damage before they have had several hours of normal running for proper break in.

Electrical Connections

The orientation of the electrical connections on the Copeland Scroll™ compressors is shown in **Figure 3** and is also shown on the wiring diagram inside the terminal box cover. The T-block screw terminals used on this compressor should be fastened with a torque of 21 to 25 in-lb (2.37 to 2.82 Nm).

A molded plug electrical option is available for compressors with internal overload protection (TF electrical code) and is noted by a 1XX series bill of material (i.e. ZP120KCE-TFD-130). The terminal cover must be installed after the molded plug is installed to help keep the plug in place.

WARNING! The molded electrical plug should be installed by hand to properly seat the plug on the electrical terminals. The plug should not be struck with a hammer or any other device.

The terminal boxes used on compressors with TW*/TE* electrical codes are larger because of the motor overload module that is housed inside of the terminal box. These terminal boxes also have a higher ingress protection (IP) rating. Every effort should be made to keep the terminal box completely sealed. Oversized

conduits, poor conduit connections to the terminal box, an incorrectly installed terminal box cover or a missing terminal box cover gasket are a few possible air leakage paths. **CAUTION! Moisture from warm, moist air that is permitted to freely enter the terminal box can condense into droplets of water inside the cooler terminal box of the compressor. To alleviate this problem, the warm, moist air must be prevented from entering the terminal box. Sealing conduits and eliminating other air leakage paths must be taken. Dow Corning 3165 RTV is ideally suited for sealing around wires in a conduit at the compressor terminal box. Drilling a hole in the bottom of the terminal box to allow the moisture to escape is not acceptable.**

“Hipot” (AC High Potential) Testing)



Use caution with high voltage and never hipot when compressor is in a vacuum.

Copeland Scroll compressors are configured with the motor down and the pumping components at the top of the shell. As a result, the motor can be immersed in refrigerant to a greater extent than hermetic reciprocating compressors when liquid refrigerant is present in the shell. In this respect, the scroll is more like semi-hermetic compressors which can have horizontal motors partially submerged in oil and refrigerant. When Copeland Scroll compressors are hipot tested with liquid refrigerant in the shell, they can show higher levels of leakage current than compressors with the motor on top. This phenomenon can occur with any compressor when the motor is immersed in refrigerant. The level of current leakage does not present any safety issue. To lower the current leakage reading, the system should be operated for a brief period of time to redistribute the refrigerant to a more normal configuration and the system hipot tested again. See **AE4-1294** for Megohm testing recommendations. **Under no circumstances should the hipot test be performed while the compressor is under a vacuum.**

Tandem Assembly

The first step in the tandem assembly process is to securely mount both compressors to the rails using the appropriate mounting hardware. After both compressors are mounted to the rails, the suction and discharge manifolds can be brazed to the appropriate stub tubes on each compressor using standard brazing practices with a nitrogen purge. See **Figure 9** for a picture of a typical tandem assembly. Special consideration needs to be given to the oil line that connects the oil sumps of the two compressors. For even tandems (two compressors with equal capacities) there are two

options for connecting the compressor oil sumps--oil equalization line (OEL) or two-phase tube line (TPTL). For uneven tandems (two compressors with unequal capacities) only the TPTL option is qualified.

After the compressors are mounted to the compressor rails the entire assembly should be tilted back a minimum of 12 degrees from horizontal (see **Figure 10**) to move the oil level away from the Schrader fittings and sight-glasses. If the compressor sumps are to be connected with the TPTL the compressor sight-glasses can now be removed for installation of the TPTL. The TPTL Rotalock fitting should be torqued to the value listed in **Table 6**. If the compressor sumps are to be connected with the OEL option the Schrader fittings can now be removed by unscrewing them. Removing the Schrader fittings exposes the stub that is used to braze the OEL to each compressor. **The oil equalization stubs of both compressors should be wiped clean with a lint free towel to remove any oil residue before brazing.**

For a detailed instruction list of how to assemble a trio of compressors, please contact Application Engineering.

SERVICE PROCEDURES

CAUTION

POE oil must be handled carefully and the proper protective equipment (gloves, eye protection, etc.) must be used when handling POE lubricant. POE must not come into contact with any surface or material that might be harmed by POE, including without limitation, certain polymers (e.g. PVC/CPVC and polycarbonate).

Field Replacement

WARNING

Use care and the appropriate material handling equipment when lifting and moving compressors. Personal safety equipment must be used.

Mounting

There is an older 7 to 15 ton scroll family (ZR*K3) as well as a reciprocating compressor family (BR) that can be replaced by this scroll compressor family. The mounting dimensions of the older scroll and the reciprocating compressor are 8.65" X 8.65" (220mm X 220mm) to the center of the mounting holes. The newer scroll has a mounting dimension of 7.5" X 7.5" (190mm X 190mm). To help adapt to this new dimension use mounting kit 922-0001-00 that contains an adaptor plate and mounting bolts. It will bolt in place of the old compressor mounts and has a 7.5" (190mm) square mounting bolt hole pattern for the new compressor.

Removing Oil

If the oil level is higher than the oil Schrader fitting on the sump of the compressor oil can be drained from this fitting until the oil level reaches the level of the Schrader fitting. To remove oil from the compressor when the oil level is below the oil Schrader fitting one of two different procedures can be used. The first procedure is to remove the compressor from the system and drain the oil from the compressor suction connection. This method ensures complete removal of the oil from the compressor. The second procedure is to remove the compressor sight-glass and insert a hose into the sump of the compressor and draw the oil out with a hand-held pump (Yellow Jacket Pump UPC#77930).

Electrical

When replacing a compressor, especially one that has been in the field for a number of years, it is always a good idea to replace the contactor.

Note: See the locked rotor on the nameplate of the new compressor and make sure the contactor exceeds this locked rotor rating.

Module

If the compressor to be replaced has a motor protection module (i.e. ZR*K3) but the new compressor does not, the following modifications must be made.

1. Entirely remove the wiring leads originally run to (T1-T2) on the solid state module from the line or transformer.
2. Either tie together the leads originally attached to the control terminals (M1-M2) on the solid state module, or remove the leads to M1-M2 and rerun the control wiring directly from the control to the contactor coil.
3. The only wiring connections to the new compressor will be the three high-power leads.

Compressor Replacement after Motor Burn

In the case of a motor burn, the majority of contaminated oil will be removed with the compressor. The rest of the oil is cleaned through use of suction and liquid line filter dryers. A 100% activated alumina suction filter drier is recommended but must be removed after 72 hours. See **AE24-1105** for clean up procedures and **AE11-1297** for liquid line filter-drier recommendations.

NOTICE It is highly recommended that the suction accumulator be replaced if the system contains one. This is because the accumulator oil return orifice or screen may be plugged with debris or may become plugged shortly after a compressor failure. This will result in starvation of oil to the replacement compressor

and a second failure.

Manifolded Compressor Replacement

! WARNING

When lifting manifolded compressor assemblies, all compressors must be lifted by their respective lifting rings. Use care and exercise extreme caution when lifting and moving compressors. Personal safety equipment must be used.

Should a compressor fail in a manifolded set, only the failed compressor should be replaced and not both compressors. The oil from the failed compressor will stay mostly in the failed compressor. Any contaminated oil that does enter the tandem circuit will be cleaned by the liquid line filter drier, and when used, the suction line filter drier.

The suction and discharge manifolds can be reused if the failed compressor is carefully removed and the manifolds are cut in such a way that a coupling and short piece of copper can reconnect the new compressor. A new oil equalization line can be field fabricated using 3/8" (10mm) OD AC&R tubing, if one is needed. The replacement oil equalization line should be formed to exactly the same outline and dimensions as the line that is being replaced. To reconnect the oil equalization line to the compressor, the oil in one or both compressors will have to be lowered below the oil fitting on the compressor. To do this, oil should either be removed from the compressors or the compressors should be tilted back a minimum of 12 degrees from horizontal to move the oil away from the fitting (see **Figure 10**).

Start-up of a New or Replacement Compressor

It is good service practice, when charging a system with a scroll compressor, to charge liquid refrigerant into the high side only. It is not good practice to dump liquid refrigerant from a refrigerant cylinder into the crankcase of a stationary compressor. If additional charge is required, charge liquid into the low side of the system with the compressor operating. **WARNING! Do not start the compressor while the system is in a deep vacuum.** Internal arcing may occur when any type of compressor is started in a vacuum. **NOTICE Do not operate the compressor without enough system charge to maintain at least 55 psig (3.8 bar) suction pressure for R-410A and 20 psig (1.4 bar) for R-22 & R-407C. Do not operate with a restricted suction or liquid line. Do not operate with the low pressure cut-out disabled.** Never install a system in the field and leave it unattended with no charge, a holding charge, or with the service valves closed without securely locking out the system. This will prevent unauthorized personnel from accidentally ruining the compressor by operating with no refrigerant flow.

As mentioned in the **Manifolded Applications** section, attention must be given to compressor oil levels when commissioning a new system and servicing an existing system. Oil levels should be checked with the compressor "off" and after the oil has had a chance to equalize between the compressors (for manifolded applications). If oil can't be seen in the sight-glass of the compressor, add oil until the sight-glass is approximately half full.

Field Trouble Shooting the Kriwan Module

Follow the steps listed below to trouble shoot the module in the field. See wiring diagram **Figure 3** or in terminal box cover.

1. De-energize control circuit and module power. Remove the control circuit wires from the module (Terminals M1 & M2). Connect a jumper across these "control circuit" wires. This will bypass the "control contact" of the module.

CAUTION ! The motor protection system within the compressor is now bypassed. Use this configuration to temporarily test module only.

Re-energize the control circuit and module power.

If the compressor will not operate with the jumper installed, then the problem is external to the solid state protection system.

If the compressor operates with the module bypassed but will not operate when the module is reconnected, then the control circuit relay in the module is open. The thermistor protection chain now needs to be tested to determine if the module's control circuit relay is open due to excessive internal temperatures or a faulty component.

2. Check the thermistor protection chain located in the compressor as follows:

De-energize control circuit and module power. Remove the sensor leads from the module (S1 & S2). Measure the resistance of the thermistor protection chain through these sensor leads with an ohmmeter.

NOTICE ! Use an Ohmmeter with a maximum of 9 volts to check the sensor chain. The sensor chain is sensitive and easily damaged; no attempt should be made to check continuity through it with anything other than an ohmmeter. The application of any external voltage to the sensor chain may cause damage requiring the replacement of the compressor.

The diagnosis of this resistance reading is as follows:

- 200 to 2250 ohms – Normal operating range
- 2750 ohms or greater – Compressor overheated – Allow time to cool
- zero resistance – Shorted sensor circuit – Replace the compressor
- infinite resistance – Open sensor circuit – Replace the compressor

If the resistance reading is abnormal, remove the sensor connector plug from the compressor and measure the resistance at the sensor fusite pins. This will determine if the abnormal reading was due to a faulty connector

On initial start-up, and after any module trip, the resistance of the sensor chain must be below the module reset point before the module circuit will close. Reset values are 2250-3000 ohms.

3. If the sensor chain has a resistance that is below 2250 ohms, and the compressor will run with the control circuit bypassed, but will not run when connected properly, the solid state module is defective and should be replaced. The replacement module must have the same supply voltage rating as the original module.

NOTE: The Kriwan INT69 SU2 has been phased out of production by Kriwan. Kriwan modules that require replacement in the field should be replaced with the CoreSense Communications module listed in Table 4. Kriwan to CoreSense retrofit instructions are listed at the end of this bulletin.

Field Troubleshooting CoreSense Communications Module

A solid green LED indicates the module is powered and operation is normal. A solid red LED indicates an internal problem with the module. If a solid red LED is encountered, power down the module (interrupt the T1-T2 power) for 30 seconds to reboot the module. If a solid red LED is persistent, change the CoreSense module.

CoreSense communicates **Warning** codes via a green flashing LED. **Warning** codes do not result in a trip or lockout condition. **Alert** codes are communicated via a red flashing LED. **Alert** codes will result in a trip condition and possibly a lockout condition. **Table 6** lists the flash code information for **Warning** and **Alert** codes along with code reset and troubleshooting information. For more information on CoreSense please refer to **AE8-1384**.

Copeland Scroll Compressor Functional Check

A functional compressor test with the suction service valve closed to check how low the compressor will pull suction pressure is **not** a good indication of how well a compressor is performing. **Such a test may damage a scroll compressor.** The following diagnostic procedure should be used to evaluate whether a Copeland Scroll compressor is working properly.

1. Proper voltage to the unit should be verified.
2. The normal checks of motor winding continuity and short to ground should be made to determine if the inherent overload motor protector has opened or if an internal motor short or ground fault has developed. If the protector has opened, the compressor must be allowed to cool sufficiently to allow it to reset.
3. Proper indoor and outdoor blower/fan operation should be verified.
4. With service gauges connected to suction and discharge pressure fittings, turn on the compressor. If suction pressure falls below normal levels, the system is either low on charge or there is a flow blockage in the system.
5. If suction pressure does not drop and discharge pressure does not rise to normal levels, reverse any two of the compressor power leads and reapply power to make sure compressor was not wired to run in reverse direction. If pressures still do not move to normal values, either the reversing valve (if so equipped) or the compressor is faulty. Reconnect the compressor leads as originally configured and use normal diagnostic procedures to check operation of the reversing valve.
6. To test if the compressor is pumping properly, the compressor current draw must be compared to published compressor performance curves using the operating pressures and voltage of the system. If the measured average current deviates more than $\pm 15\%$ from published values, a faulty compressor may be indicated. A current imbalance exceeding 15% of the average on the three phases should be investigated further. A more comprehensive trouble-shooting sequence for compressors and systems can be found in Section H of the **Emerson Electrical Handbook, Form No. 6400**.
7. Before replacing or returning a compressor: Be certain that the compressor is actually inoperable. As a minimum, recheck a compressor returned

from the field in the shop or depot for Hipot, winding resistance, and ability to start before returning. More than one-third of compressors returned to Emerson Climate Technologies, Inc. for warranty analysis are determined to have nothing found wrong. They were misdiagnosed in the field as being inoperable. Replacing working compressors unnecessarily costs everyone.

Refrigerant Retrofits

NOTICE

ZR compressors are UL recognized for use with R-22, R-407C, or R-134a only. Use of any other refrigerants will void the compressor UL recognition.

Only those systems that are in need of service should be considered for a refrigerant retrofit if R-22 is not available. Systems that are operating without issue should be maintained and not be considered for a refrigerant retrofit. In most if not all cases, the retrofitted system will not be as energy efficient as the R-22 system.

Only those refrigerants approved by Emerson Climate Technologies, Inc. and the OEM should be considered. For a list of Emerson approved refrigerants please refer to Form **93-11, Refrigerants and Lubricants Approved for Use in Copeland Compressors**. Please consult with the OEM to obtain their input and approval on refrigerant retrofitting.

If the compressor lubricant is mineral oil, it must be changed to POE for a successful retrofit. See the section **Removing Oil** for instructions on how to remove the oil charge from the compressor.

POE oil should be added to the compressor through the oil charging connection on the sump of the compressor. The compressor should be filled to 1/2 sight-glass.

For detailed R-407C retrofit instructions please refer to Form **95-14, Refrigerant Changeover Guidelines for R-22 to R-407C**. For other retrofit guidelines please refer to the equipment OEM.

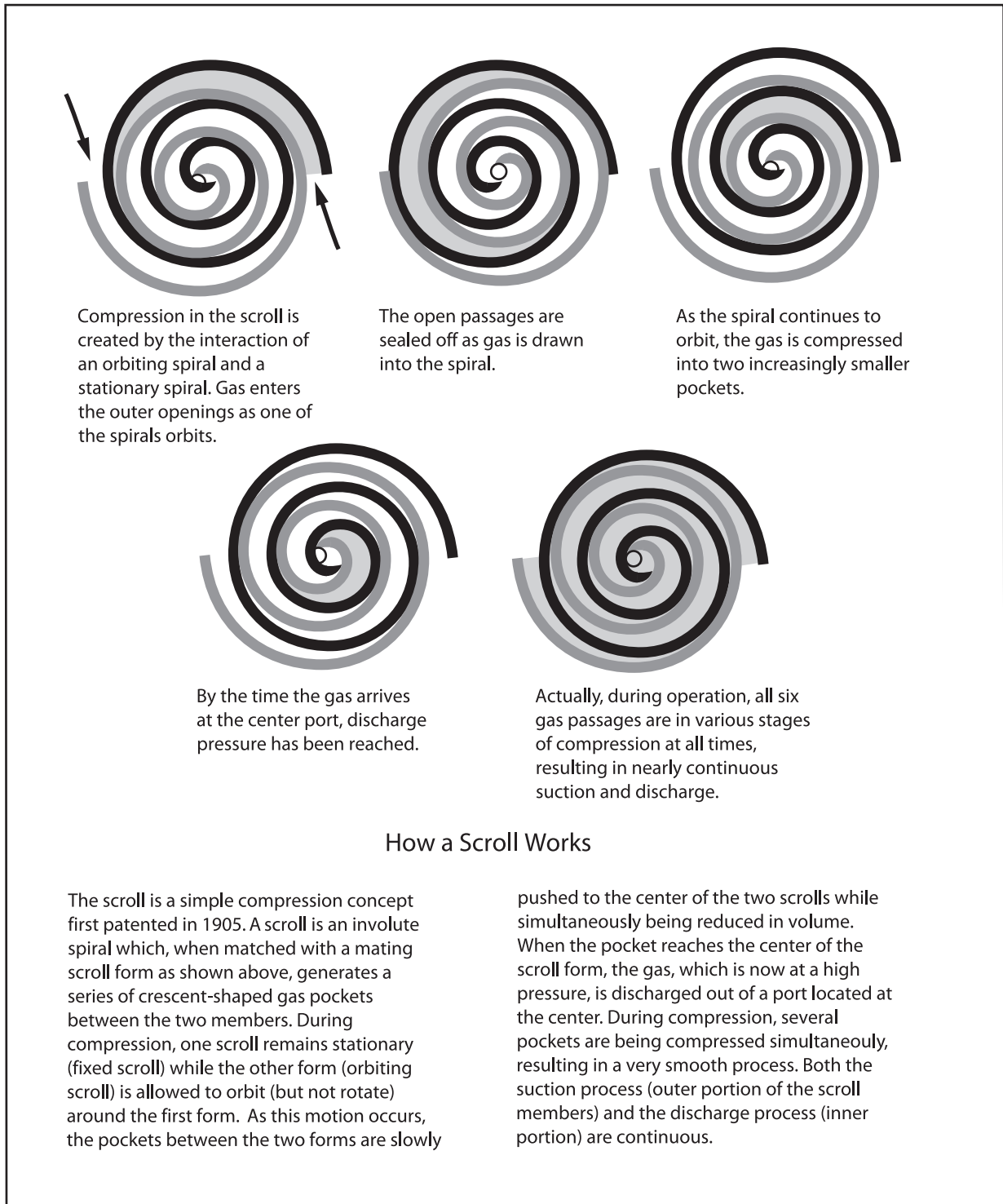

Figure 1

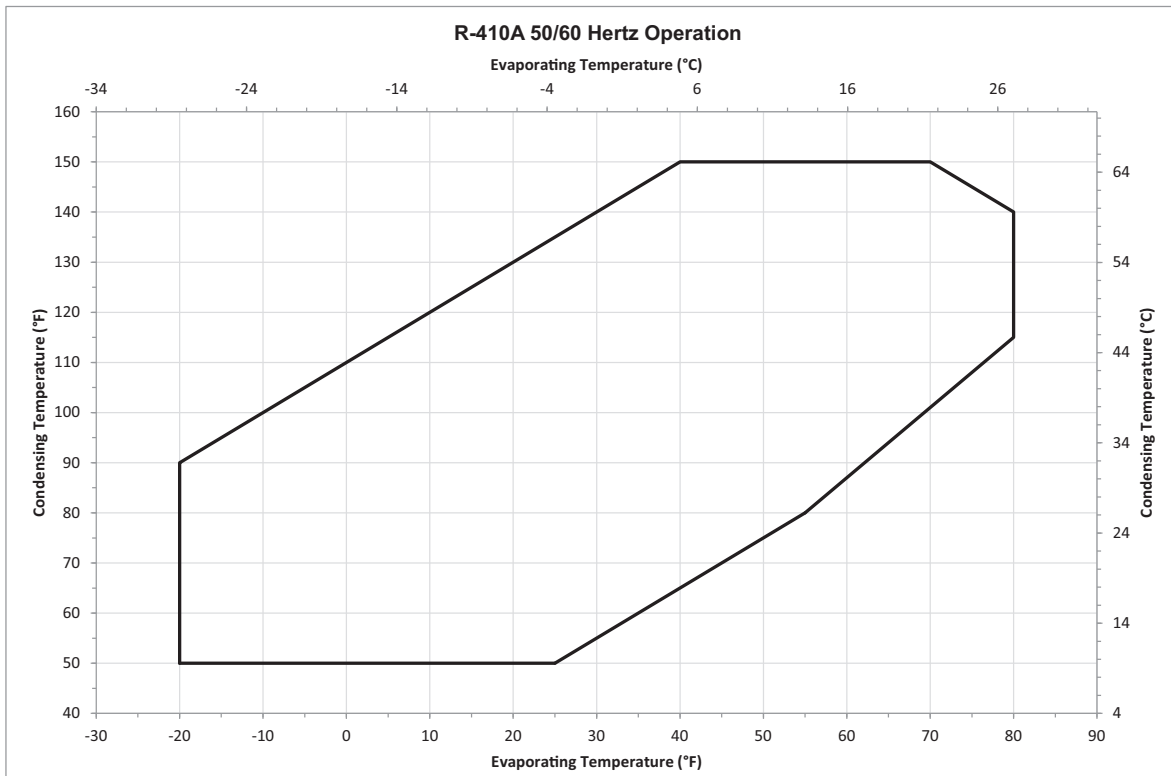
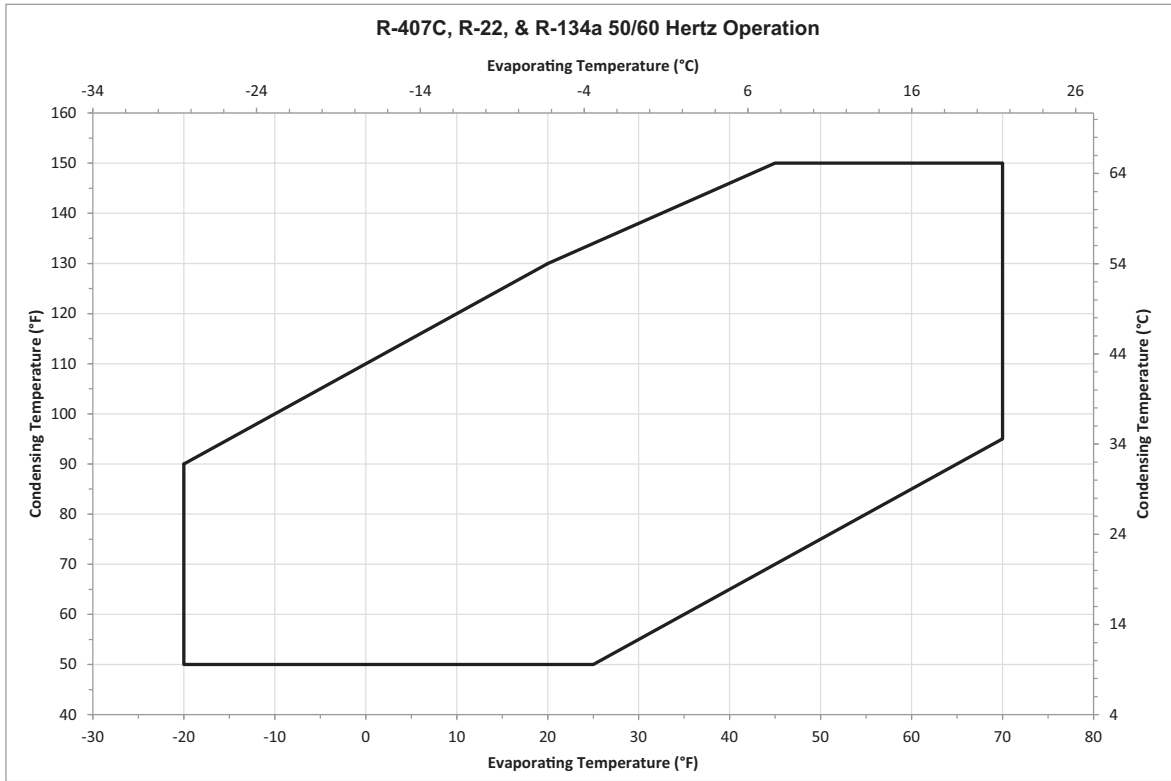

Figure 2 – Scroll Operating Envelopes

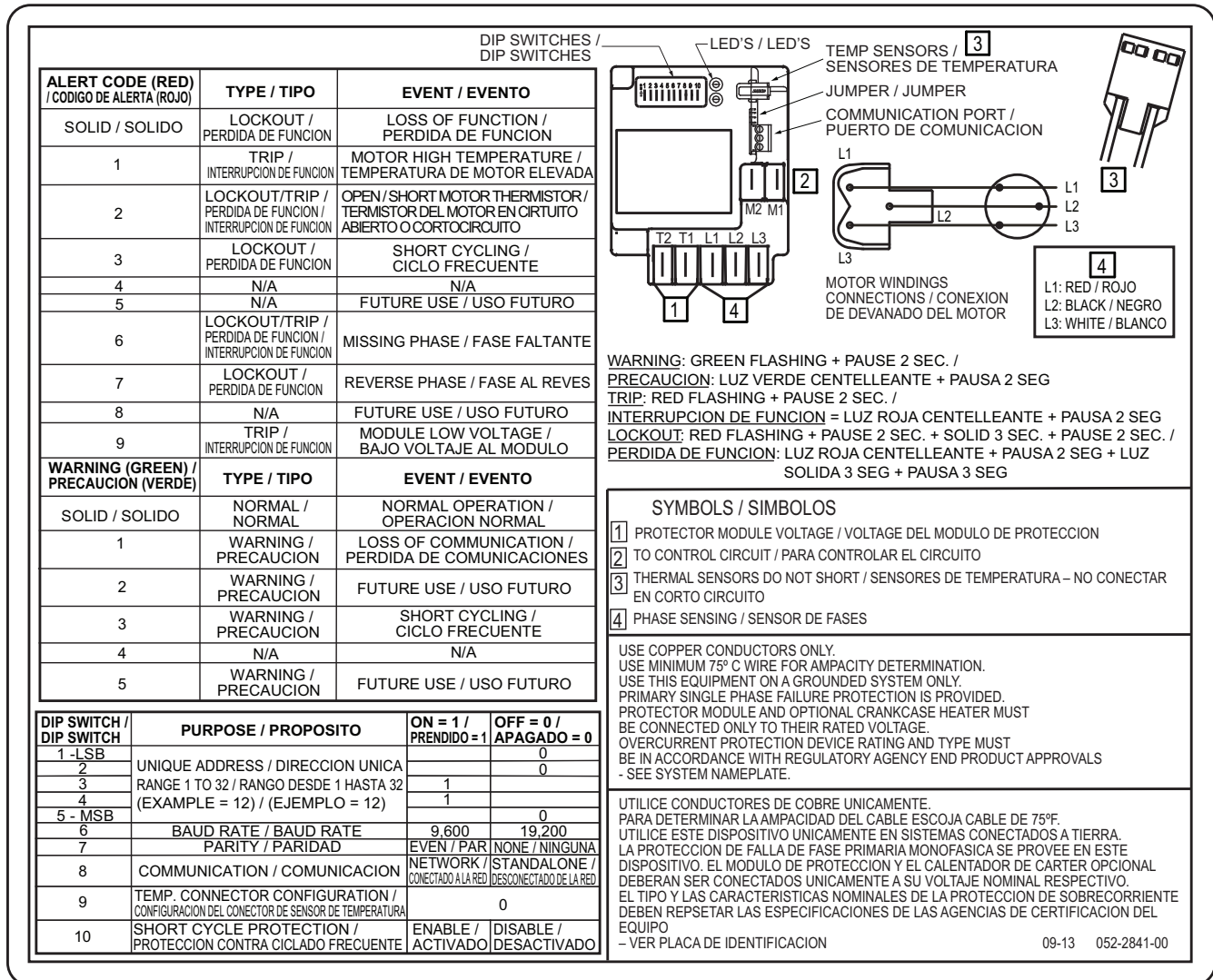
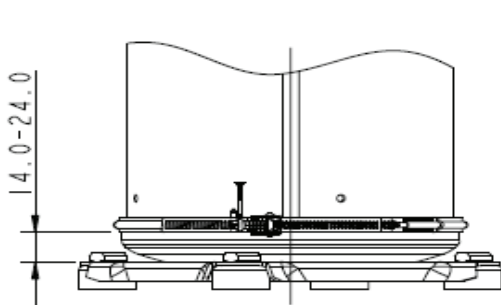
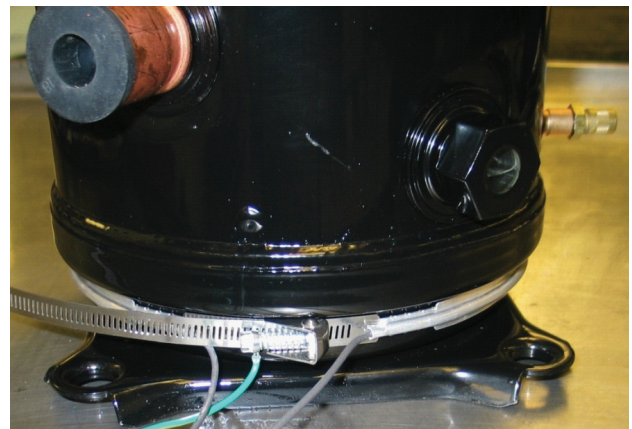
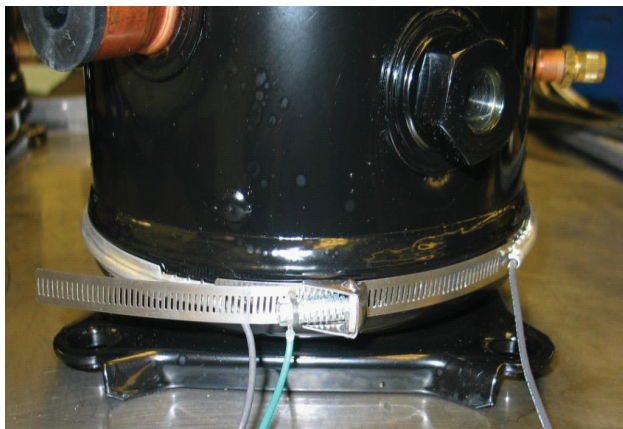

Figure 3
Compressor Terminal Box Wiring with CoreSense Protection



Figure 4
ASTP Label



ZR84-144KC
ZP90-137KC

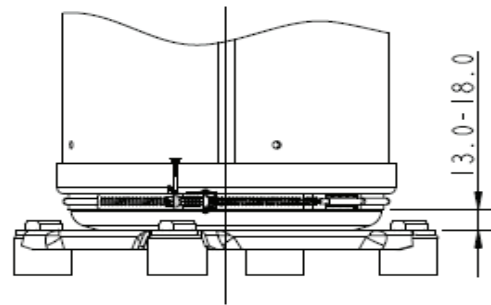

ZR160-190KC
ZP154-182KC

Figure 5
Crankspace Heater Location

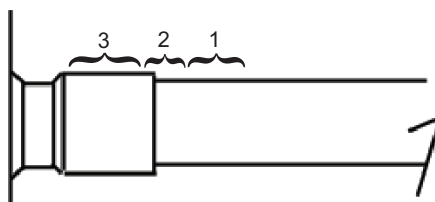

Figure 6
Scroll Suction Tube Brazing

New Installations

- The copper-coated steel suction tube on scroll compressors can be brazed in approximately the same manner as any copper tube.
- Recommended brazing materials: Any silfos material is recommended, preferably with a minimum of 5% silver. However, 0% silver is acceptable.
- Be sure suction tube fitting I.D. and suction tube O.D. are clean prior to assembly. If oil film is present wipe with denatured alcohol, Dichloro-Trifluoroethane or other suitable solvent.
- Using a double-tipped torch apply heat in Area 1. As tube approaches brazing temperature, move torch flame to Area 2.
- Heat Area 2 until braze temperature is attained, moving torch up and down and rotating around tube as necessary to heat tube evenly. Add braze material to the joint while moving torch around joint to flow braze material around circumference.
- After braze material flows around joint, move torch to heat Area 3. This will draw the braze material down into the joint. The time spent heating Area 3 should be minimal.
- As with any brazed joint, overheating may be detrimental to the final result.

Field Service

WARNING

Remove refrigerant charge from both the low and high side of the compressor before cutting the suction and discharge lines to remove the compressor. Verify the charge has been completely removed with manifold gauges.

- To disconnect: Reclaim refrigerant from both the high and low side of the system. Cut tubing near compressor.
- To reconnect:
 - Recommended brazing materials: Silfos with minimum 5% silver or silver braze material with flux.
 - Insert tubing stubs into fitting and connect to the system with tubing connectors.
 - Follow **New Installation** brazing

Table 2
Field Application Test

Outdoor Ambient	85°F (29°C)	95°F (35°C)	105°F (40°C)
System On-Time (Minutes)	7	14	54
System Off-Time (Minutes)	13	8	6
Number of On/Off Cycles	5	5	4

Table 3
Design Configurations

Recommended Configuration	
Component	Description
Tubing Configuration	Shock loop
Service Valve	"Angled valve" fastened to unit
Suction muffler	Not required
Alternate Configuration	
Component	Description
Tubing Configuration	Shock loop
Service Valve	"Straight through" valve not fastened to unit
Mass / Suction muffler	May be required (acts as dampening mass)

Table 4 - Compressor Accessories & Service Parts

Part Category	Part Description	ZR84-144KC	ZR160-190KC	ZP90-137KC	ZP154-182KC
Mounting	Spacer-Mounting Kit	527-0116-00	527-0186-00	527-0116-00	527-0186-00
Crankcase Heater	Crankcase Heater, 120V	018-0091-21	018-0091-21	018-0091-21	018-0091-21
	Crankcase Heater, 240V	018-0091-22	018-0091-22	018-0091-22	018-0091-22
	Crankcase Heater, 480V	018-0091-23	018-0091-23	018-0091-23	018-0091-23
	Crankcase Heater, 575V	018-0091-24	018-0091-24	018-0091-24	018-0091-24
	Crankcase Heater Junction Box	998-7029-00	998-7029-00	998-7029-00	998-7029-00
Oil	Oil Sight-Glass Kit	998-0010-00	998-0010-00	998-0010-00	998-0010-00
	Oil Sight-Glass Rotalock O-ring	020-0028-05	020-0028-05	020-0028-05	020-0028-05
	Blank Cap To Cover Sight-Glass	005-1514-00	005-1514-00	005-1514-00	005-1514-00
	POE Oil (1 Gallon)	998-E022-01	998-E022-01	998-E022-01	998-E022-01
	Oil Access Fitting	510-0715-00	510-0715-00	510-0715-00	510-0715-00
Electrical	Terminal Box & Cover Assembly ¹				
	Terminal Block	021-0227-03 ²	021-0100-00 ³ 021-0227-03 ⁴	021-0227-03 ²	021-0100-00 ³ 021-0227-03 ⁴
	Ground Screw (10-32, self tapping)	100-0605-01		100-0605-01	
	Terminal Block Screw (10-32 x .5" Long)	100-0550-01	100-0550-01	100-0550-01	100-0550-01
	Molded Plug (TF* Electricals Only)	529-0099-00		529-0099-00	
Protection	Kriwan Module 120/240V	not required	replace with CoreSense	not required	replace with CoreSense
	Kriwan Module 24 V	not required		not required	
	Kriwan Diagnose Module 120/240V	not required	971-0641-00	not required	971-0641-00
	Kriwan Diagnose Module 24 V	not required	971-0641-01	not required	971-0641-01
	CoreSense Module Kit 120/240V	not required	971-0064-05	not required	971-0064-05
	CoreSense Module Kit 24V	not required	971-0065-04	not required	971-0065-04
	Commercial Comfort Alert	543-0038-02		543-0038-02	
	Discharge Line Thermostat	998-0071-02	998-0071-02	998-0071-02	998-0071-02
Suction & Discharge	Discharge 1/4" Schrader Fitting	510-0370-00	510-0370-00	510-0370-00	510-0370-00
	Discharge Rotalock O-Ring Seal	020-0028-02	020-0028-02	020-0028-02	020-0028-02
	Suction Rotalock O-Ring Seal	020-0028-03	020-0028-03	020-0028-03	020-0028-03
	Rotalock Service Valve, Suction 1-3/8"	998-0510-46	998-0510-46	998-0510-46	998-0510-46
	Rotalock Service Valve, Discharge 7/8"	998-0510-90	998-0510-90	998-0510-90	998-0510-90
	Discharge Rotalock Adapter to 7/8" Sweat	998-0034-08	998-0034-08	998-0034-08	998-0034-08
	Suction Rotalock Adapter to 1-3/8" Sweat	998-0034-13	998-0034-13	998-0034-13	998-0034-13

¹ Terminal boxes are rarely replaced; please contact Application Engineering if replacement part numbers are required

² All Voltages

³ 200/230 Volts Only

⁴ 380, 460, 575 Volts

**Table 5
Refrigerant Charge Limits**

Model	Charge Limit	
	Pounds	kg
ZR84-144KC	16	7.2
ZR160-190KC	18	8.2
ZRT168-288KC*	24	10.9
ZRU178-233KC**	24	10.9
ZRT320-380KC*	27	12.2
ZRU269-350KC**	27	12.2
ZP90-137KC	16	7.2
ZP154-182KC	18	8.2
ZPT180-274KC*	24	10.9
ZPU193-257KC**	24	10.9
ZPT308-364KC*	27	12.2
ZPU274-336KC**	27	12.2

*Even Tandem Assembly

**Uneven Tandem Assembly

**Table 6
Torque Values**

Part	Torque		
	ft-lb	in-lb	N-m
Sight-Glass & TPTL Rotalock Fitting	74-81	885-975	100-110
Discharge Rotalock Valve	95-103	1150-1240	130-140
Suction Rotalock Valve	125-132	1505-1593	170-180
Schrader Valve	3.3-5.0	40-60	4.5-6.8
Terminal Block Screws	2	25	2.8
10-32 Green Ground Screw	2	25	2.8
M6 Terminal Box Mounting Stud Nuts	3.5-3.9	42-47	4.7-5.3

Table 7 – Protector Specifications

Module P/N	071-0660-01	071-0660-00	071-0686-01	071-0686-00	571-0065-05	571-0064-06
Compressor Motor Code	TW	TW	TW	TW	TE	TE
Type	Kriwan	Kriwan	Kriwan Diagnose*	Kriwan Diagnose*	CoreSense	CoreSense
T1-T2 Voltage (AC)	24	120/240	24	120/240	24	120/240
Power Consumption (VA)	3	3	3	3	5	5
M1-M2 Contact Rating (A)	2.5	2.5	2.5	2.5	2.5	2.5
M1-M2 Minimum Current (A)	> 0.02	> 0.02	> 0.02	> 0.02	N/A	N/A
M1-M2 Maximum Voltage	240	240	240	240	240	240
Trip Point (Ω)	>4.5KΩ	>4.5KΩ	>4.5KΩ	>4.5KΩ	>4.5KΩ (motor)	>4.5KΩ (motor)
Reset Point (Ω)	<2.75KΩ	<2.75KΩ	<2.75KΩ	<2.75KΩ	<2.75KΩ (motor)	<2.75KΩ (motor)
Reset Time	30 minutes	30 minutes	30 minutes	30 minutes	30 minutes	30 minutes
Features	Motor Protection				Motor Protection, Phase Protection, Communications	

* Diagnose features not supported

Table 8 – CoreSense™ Communications LED Flash Code Information

The flash code number corresponds to the number of LED flashes, followed by a pause, and then the flash code is repeated. A lockout condition produces a red flash, followed by a pause, a solid red, a second pause, and then repeated.

Status	Fault Condition	Code Fault Description	Code Reset Description	Troubleshooting Information
Solid Green	Normal Operation	Module is powered and operation is normal	N/A	N/A
Solid Red	Module Malfunction	Module has internal fault	N/A	1) Reset module by removing power from T2-T1 2) Replace module
Warning LED Flash				
Green Flash Code 1	Loss of Communication	Module and master controller have lost communications with each other for more than 5 minutes	When communications are confirmed	1) Check the control wiring 2) Verify dipswitch 8 is "on"
Green Flash Code 2	Future Use	N/A	N/A	N/A
Green Flash Code 3	Short Cycling	Run time of less than 1 minute; number of short cycles exceeds 48 in 24 hours	< 48 short cycles in 24 hours	1) Check system charge and pressure control setting 2) Adjust set-point of temperature controller 3) Install anti-short cycling control
Green Flash Code 4	Not used with this compressor family	N/A	N/A	N/A
Green Flash Code 5	Future Use	N/A	N/A	N/A

Table 8 Continued

Status	Fault Condition	Code Fault Description	Code Reset Description	Troubleshooting Information
Alert/Lockout LED Flash				
Red Flash Code 1	Motor High Temperature	$\Omega > 4.5K$; Lockout after 5 Alerts	$\Omega < 2.75K$ and 30 minutes	<ol style="list-style-type: none"> 1) Check supply voltage 2) Check system charge & superheat 3) Check contactor
Red Flash Code 2	Open/Shorted Motor Thermistor	$\Omega > 220K$ or $\Omega < 40$; lockout after 6 hours	$40 < \Omega < 2.75K$ and 30 minutes	<ol style="list-style-type: none"> 1) Check for poor connections at module and thermistor fusite 2) Check continuity of thermistor wiring harness
Red Flash Code 3	Short Cycling	Run time of less than 1 minute; lockout if the number of Alerts exceeds the number configured by the user in 24 hours	Interrupt power to T2-T1 or perform Modbus reset command	<ol style="list-style-type: none"> 1) Check system charge and pressure control setting 2) Adjust set-point of temperature controller 3) Install anti-short cycling control
Red Flash Code 4	Not used with this family of compressors	N/A	N/A	N/A
Red Flash Code 5	Future Use	N/A	N/A	N/A
Red Flash Code 6	Missing Phase	Missing phase; Lockout after 10 consecutive Alerts	After 5 minutes and missing phase condition is not present	<ol style="list-style-type: none"> 1) Check incoming power 2) Check fuses/breakers 3) Check contactor
Red Flash Code 7	Reverse Phase	Reverse phase; Lockout after 1 Alert	Interrupt power to T2-T1 or perform Modbus reset command	<ol style="list-style-type: none"> 1) Check incoming phase sequence 2) Check contactor 3) Check module phasing wires A-B-C
Red Flash Code 8	Future Use	N/A	N/A	N/A
Red Flash Code 9	Module Low Voltage	Low voltage on T2-T1 terminals ¹	After 5 minutes and the voltage is back in the normal range	<ol style="list-style-type: none"> 1) Verify correct module p/n 2) Check VA rating of transformer 3) Check for blown fuse in transformer secondary

¹ This Alert does not result in a Lockout

Figure 9
Tandem Oil Balancing



Oil Equalization Line



Two-Phase Tandem Line

Figure 10
Tilted Tandem

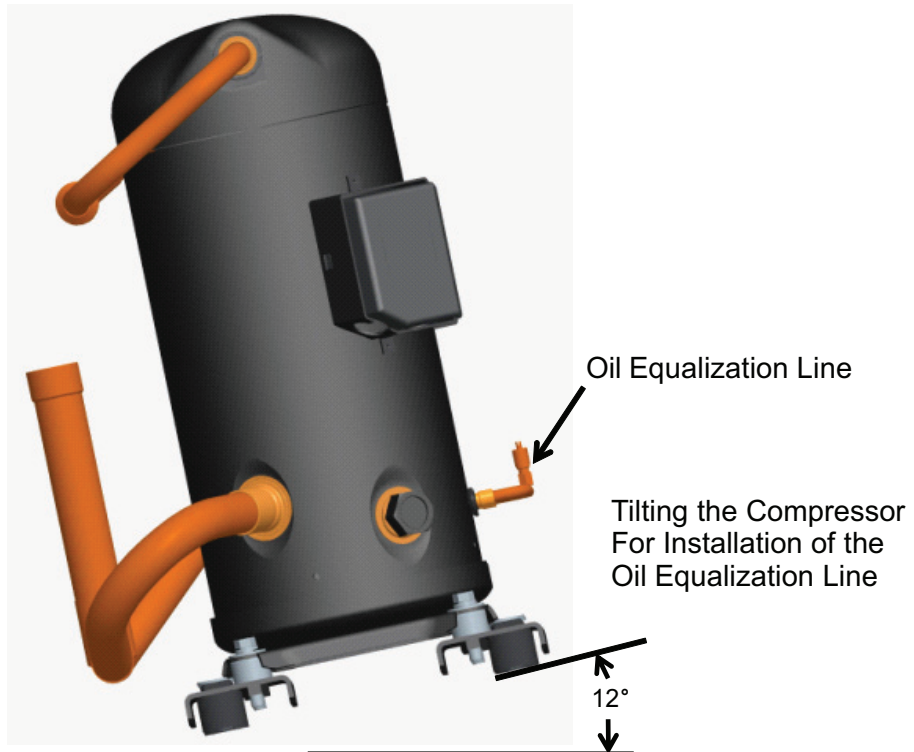

Oil Equalization Line

Tilting the Compressor
For Installation of the
Oil Equalization Line

12°

APPENDIX 1

Kriwan to CoreSense™ Communications Retrofit Instructions for ZR160-190KC & ZP154-182KC Compressors

Kriwan has discontinued production of the INT69 SU2® motor protector module that has been used with 13 & 15 ton ZR*KC, ZP*KC and ZPD*KC Copeland Scroll™ compressors. Kriwan modules that require replacement in field applications should be replaced with a CoreSense™ Communications module. Please refer to the Kriwan, CoreSense, and compressor model numbers listed in the table below.

Kriwan modules that are deemed non-operational and in-warranty should be returned through the normal channel for warranty purposes. Kriwan modules that are non-operational and out of warranty should be field scrapped in the appropriate manner.

If you have any questions, please contact your Emerson Climate Application Engineer or visit Emerson's Online Product Information (OPI) located at www.emersonclimate.com

Replacing Kriwan Module with CoreSense™ Communications

1. Disconnect and lock-out the power to the unit.
2. Using a straight blade screwdriver, carefully depress the tabs holding the terminal cover to the terminal box to remove the terminal cover. Before proceeding, use a volt meter to verify that the power has been disconnected from the unit.
3. Verify the Kriwan module part number matches one of those shown in the table below.

4. Using wire markers, label the M1, M2, T1, and T2 wires that are connected to the Kriwan module. Using needle nose pliers, remove the M1, M2, T1, T2, S1 and S2 wires from the Kriwan motor protection module.
5. Using your fingers to gently bend the tabs holding the Kriwan module in the terminal box, remove the Kriwan module from the terminal box (see picture below).

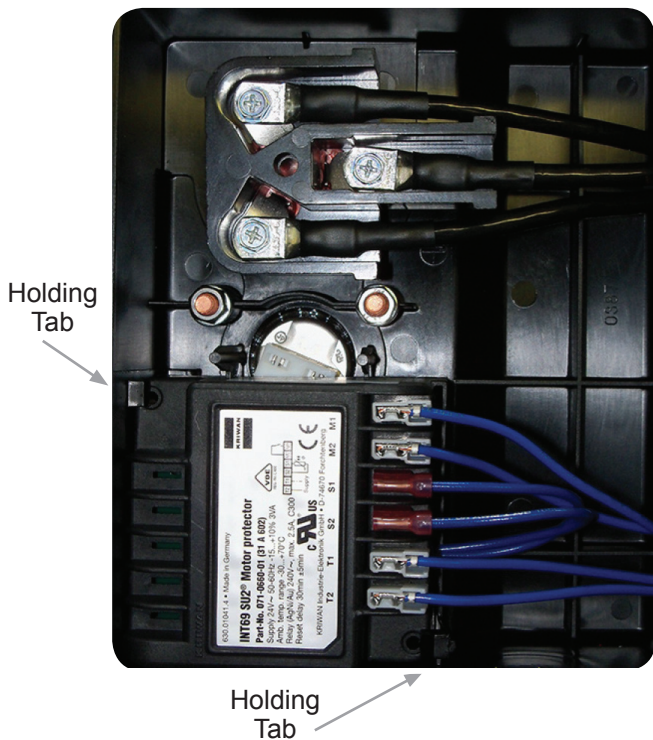

Kriwan Module Part Number	Replacement CoreSense Kit Number	Module Voltage	Compressor Model Numbers
071-0641-00/ 071-0660-01	971-0065-04	24 VAC	ZR160-190KCE-TW* ZP154-182KCE-TW*
071-0660-00	971-0064-05	120/240 VAC	

6. Using your fingers, gently pry the S1-S2 connector block from the compressor.
7. A new S1-S2 wiring harness is shipped with the CoreSense module. The wiring harness connector block should be fully inserted on the two pins.
8. Review the dip switch settings on the CoreSense module. Dip switch #1 should be “on” or in the “up” position. All other dip switches should be in the “off” or “down” position.

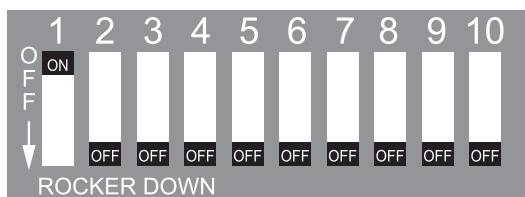

9. Route the S1-S2 wire harness so the end of the harness will not be covered by the module when it is installed. Install the CoreSense module in

the reverse manner that the Kriwan module was removed. The module should be installed as illustrated below.

10. Plug the S1-S2 harness into the 2x2 socket on the CoreSense module.
11. Connect the previously labeled M1, M2, T1, and T2 wires to the appropriate terminals on the CoreSense module.
12. Connect the L1, L2, and L3 phase sensing wires to the L1, L2, and L3 compressor terminal block connections. See the compressor terminal cover wiring diagram for identification of the L1, L2, and L3 connections on the compressor terminal block.
13. Double check the installation and make sure all connections are secure. Install the compressor terminal cover.
14. The module change is complete and the system can be put back into service.



The contents of this publication are presented for informational purposes only and are not to be construed as warranties or guarantees, express or implied, regarding the products or services described herein or their use or applicability. Emerson Climate Technologies, Inc. and/or its affiliates (collectively "Emerson"), as applicable, reserve the right to modify the design or specifications of such products at any time without notice. Emerson does not assume responsibility for the selection, use or maintenance of any product. Responsibility for proper selection, use and maintenance of any Emerson product remains solely with the purchaser or end user.